

TH9050HD - indoor ceiling/outdoor soffit

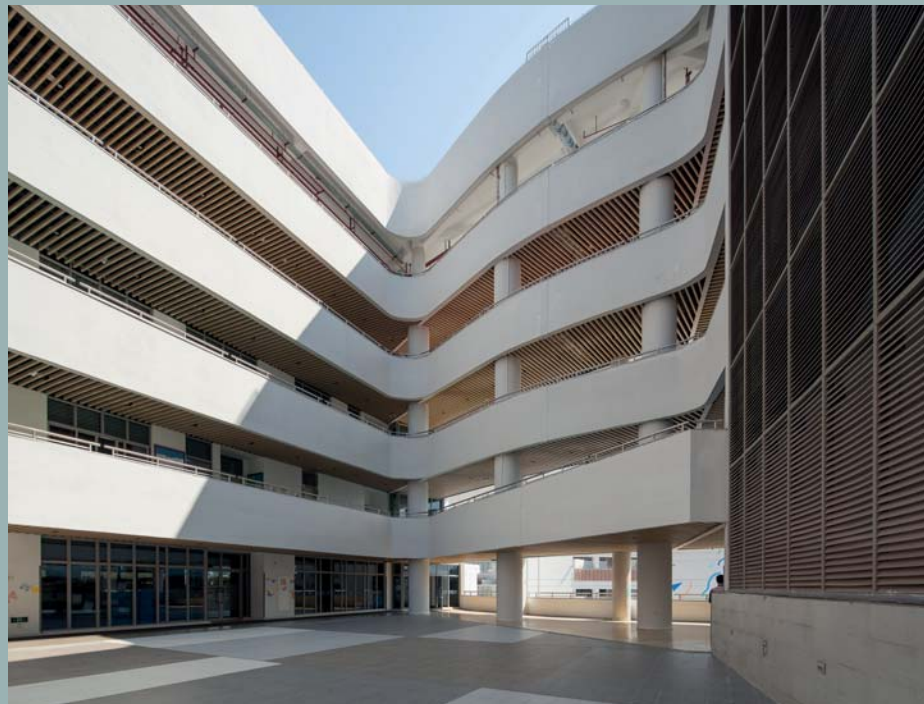

MOUNTING SYSTEM

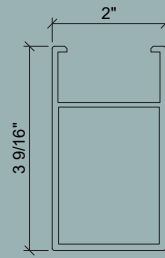
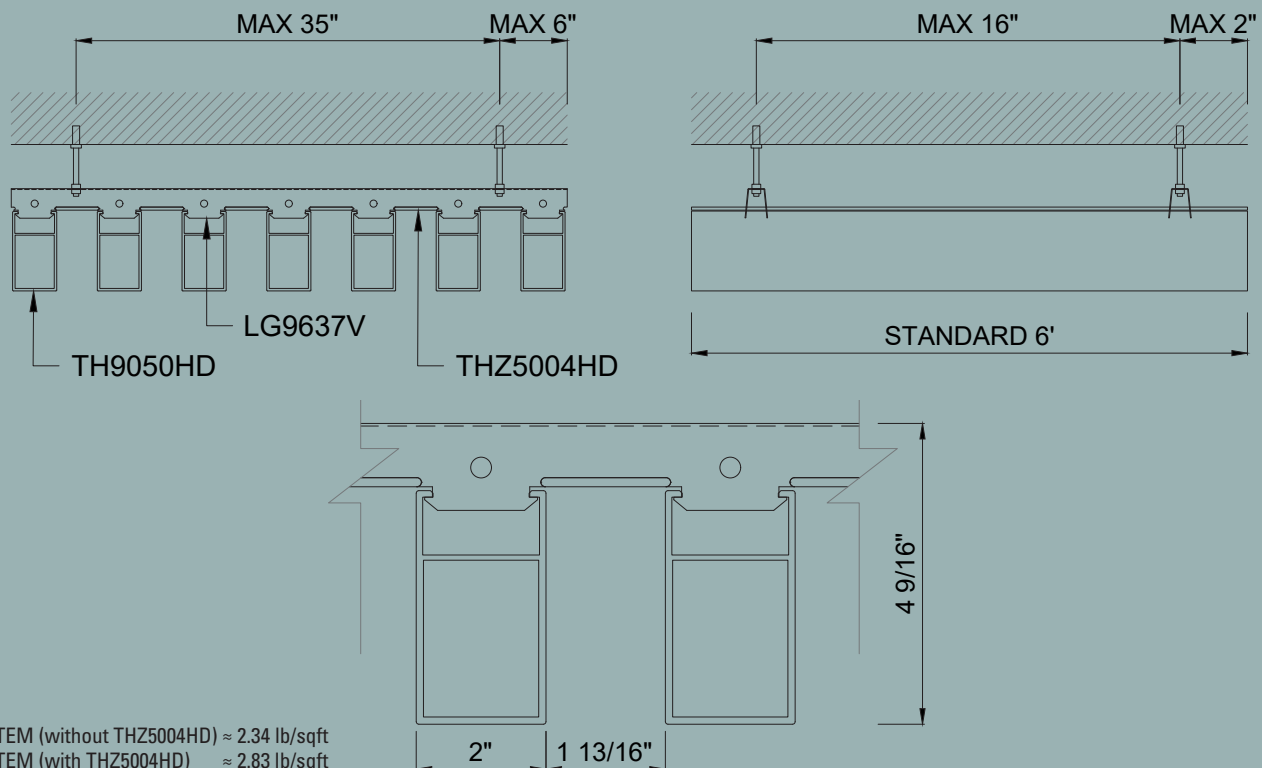

WEIGHT OF THE SYSTEM (without THZ5004HD) \approx 2.34 lb/sqft
 WEIGHT OF THE SYSTEM (with THZ5004HD) \approx 2.83 lb/sqft

ASSEMBLY INSTRUCTIONS

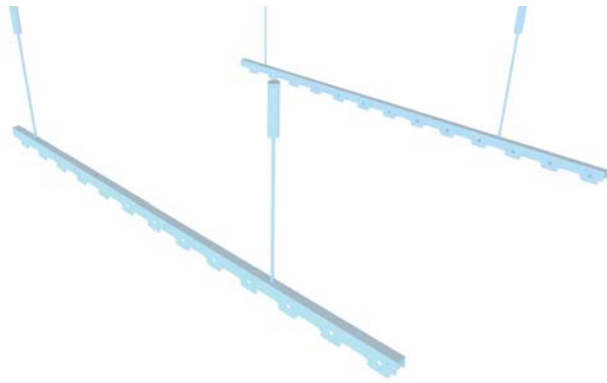

1. Fix the ZSSW-LG9637V bars directly to the ceiling using screws and wall plugs suitable for the type of support, or lower the structure with suitable hangers.

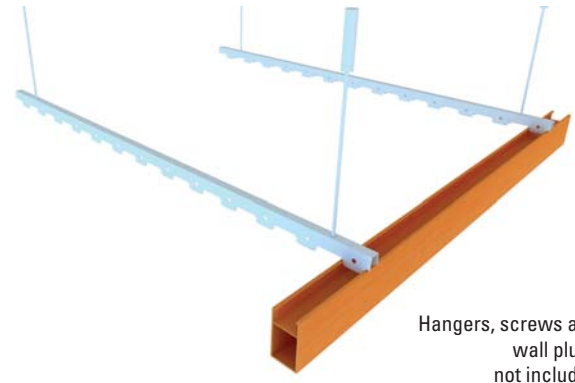

Hangers, screws and wall plugs not included

2. Install the first TH9050HD profile.



3. Attach the plank to the substructure.



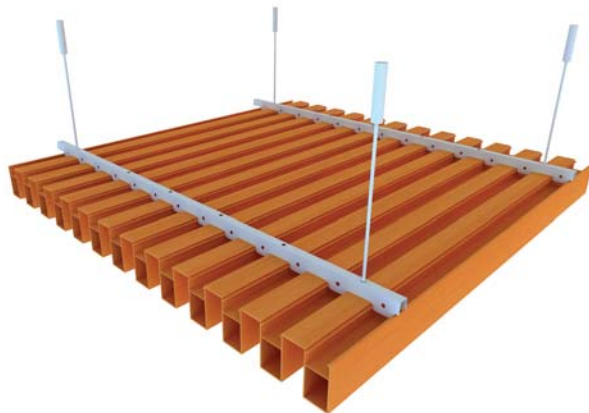

4. Install, if provided, the accessory profile THZ5004HD.



5. Complete the work by repeating the steps described in 2, 3 and 4.

NOTE: for outdoor installation, the perimeter of the ceiling must be closed on all sides.

SYSTEM COMPONENTS

Profile TH9050HD		3.20 ft/sqft	Substructure profile ZSSW-LG9637V		1.19 ft/sqft (stacked bond) 1.40 ft/sqft (running bond)
Accessory closing piece THZ5004HD		3.20 ft/sqft optional element for closing the false ceiling			

WARNING: the incidences of accessory material indicated refer to application according to the European standards, which provides for planks 6' long and slats/substructure with maximum distance o.c. up to 16". For any installation that differs from the standard a cutting plan must be designed; it shall calculate precisely the number of points of intersection between the planks and the substructure, allowing the correct identification of the number of clips and screws required for each type of application.